

Lecture 2: Moist stability, convective adjustment, PBL, RCE

Adam Sobel

Columbia University
ahs129@columbia.edu

December 3, 2013

Overview

- 1 Moist stability
- 2 Parcel theory
- 3 CAPE and CIN
- 4 Thermodynamic diagrams
- 5 Dry convective boundary layer over land
- 6 Moist convective asymmetry and tropical atmospheric structure
- 7 Radiative-convective equilibrium

Our treatment of moist stability follows a mix of Emanuel (1994) and Bohren and Albrecht.

Moist stability, 0

If the air remains unsaturated, then the only effect of water vapor is the virtual temperature effect. We can define a virtual potential temperature, θ_v ,

$$\theta_v = T_v \left(\frac{p_0}{p} \right)^{R_d/c_p},$$

θ_v is conserved, just as θ is, for dry adiabatic transformations — that is, transformations which are both adiabatic and in which no phase change occurs. Also just as θ , we can compute density from θ if we know p . The buoyancy frequency can be shown to be

$$N^2 = \frac{g}{\theta_v} \frac{\partial \theta_v}{\partial z}.$$

This is exactly analogous to the dry atmosphere, except $\theta \rightarrow \theta_v$. Without phase change, water vapor just changes the atmospheric composition in a minor way; nothing really new happens.

If the atmosphere is saturated, then $\theta_e = \theta_e^*$ is a function only of temperature. To the extent we can neglect condensate effects, θ_e can be shown to be uniquely related to density (given the pressure). We can then show that the stability to small vertical displacements depends on the sign of the vertical potential temperature gradient, being stable if

$$\frac{\partial \theta_e}{\partial z} > 0,$$

unstable for

$$\frac{\partial \theta_e}{\partial z} < 0.$$

(Essentially the same statements are true substituting moist static energy, h , for θ_e .)

Moist stability, 2

However once phase change can occur — so the air can neither be assumed entirely saturated nor entirely unsaturated — the picture changes fundamentally. θ_v is not conserved under condensation or evaporation, even if reversible. θ_e or h may be conserved; but we cannot compute density from either of these alone without also knowing the water vapor content, r (or q).

This is a fundamental difference between moist and dry convection, and an irreducible complexity of moist atmospheres: **there is no single variable which is both conserved and uniquely related to density**, given the pressure.

Moist stability, 3 - moist adiabatic lapse rate

Consider the adiabatic ascent of a saturated air parcel. What is its temperature as a function of height? This is called the *moist adiabatic lapse rate*. A somewhat long, tedious, and approximate calculation yields (cf. Bohren and Albrecht)

$$\frac{dT}{dz} = \Gamma_m = -\frac{g}{c_p} - \frac{1}{c_p} \frac{d}{dz}(r^* L_v).$$

With some more work we can get rid of the derivatives,

$$\frac{dT}{dz} \approx -\frac{g}{c_p} \frac{1 + L_v r^* / RT}{1 + L_v^2 r^* / c_p R_v T^2}$$

Note $\Gamma_d = -g/c_p \approx -10$ K/km is the dry adiabatic lapse rate. Since r^* will decrease with height, $\Gamma_m > \Gamma_d$ ($|\Gamma_m| < |\Gamma_d|$).

Near the surface in the tropics, we may have $\Gamma_m \sim -5$ K/km, while in the upper troposphere r^* is very small and $\Gamma_m \approx \Gamma_d$.

Moist stability, 4 - moist adiabatic lapse rate

In reality, the tropical lapse rate is very close to moist adiabatic, suggesting that it has undergone **convective adjustment**. Convection has rendered the profile close to neutral to ascent of a saturated parcel.

This is somewhat analogous to the uniform density in the interior in Rayleigh-Benard convection, although we will see that the **physics are actually quite different**. In RBC, the homogenization of density occurs by simple mixing. If that were the case here, we would also expect humidity to be homogenized, which would lead to saturation on the large scale. That is not what we find.

(ITCZ soundings here.)

Soundings from E. Pacific ITCZ TEPPS experiment, Northern Summer 1997

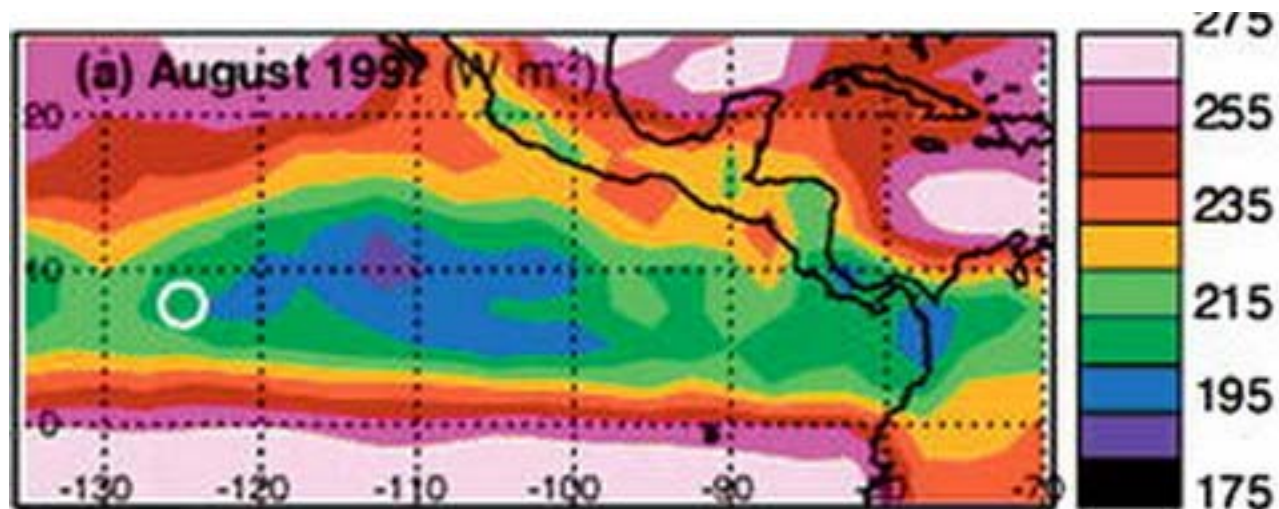
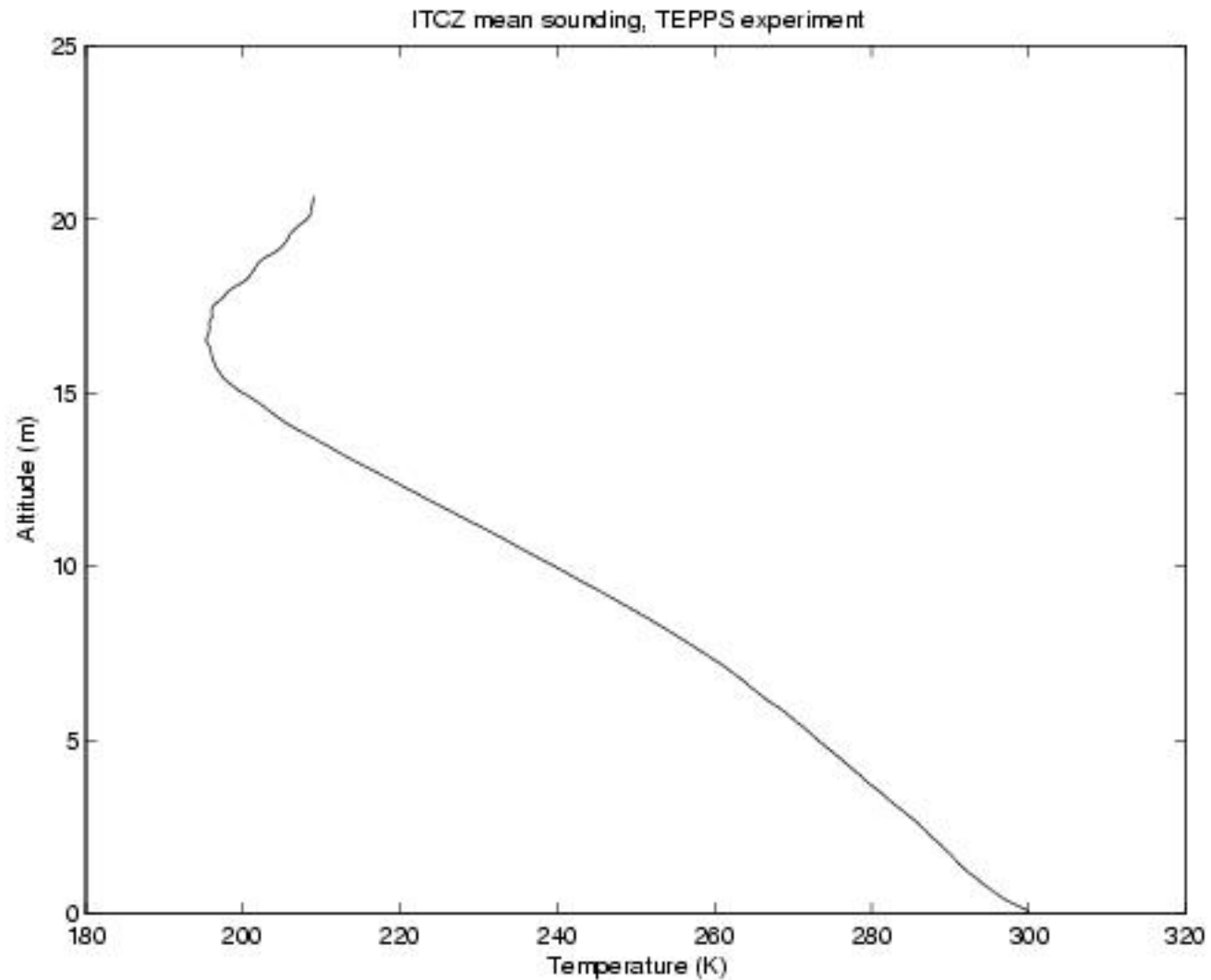
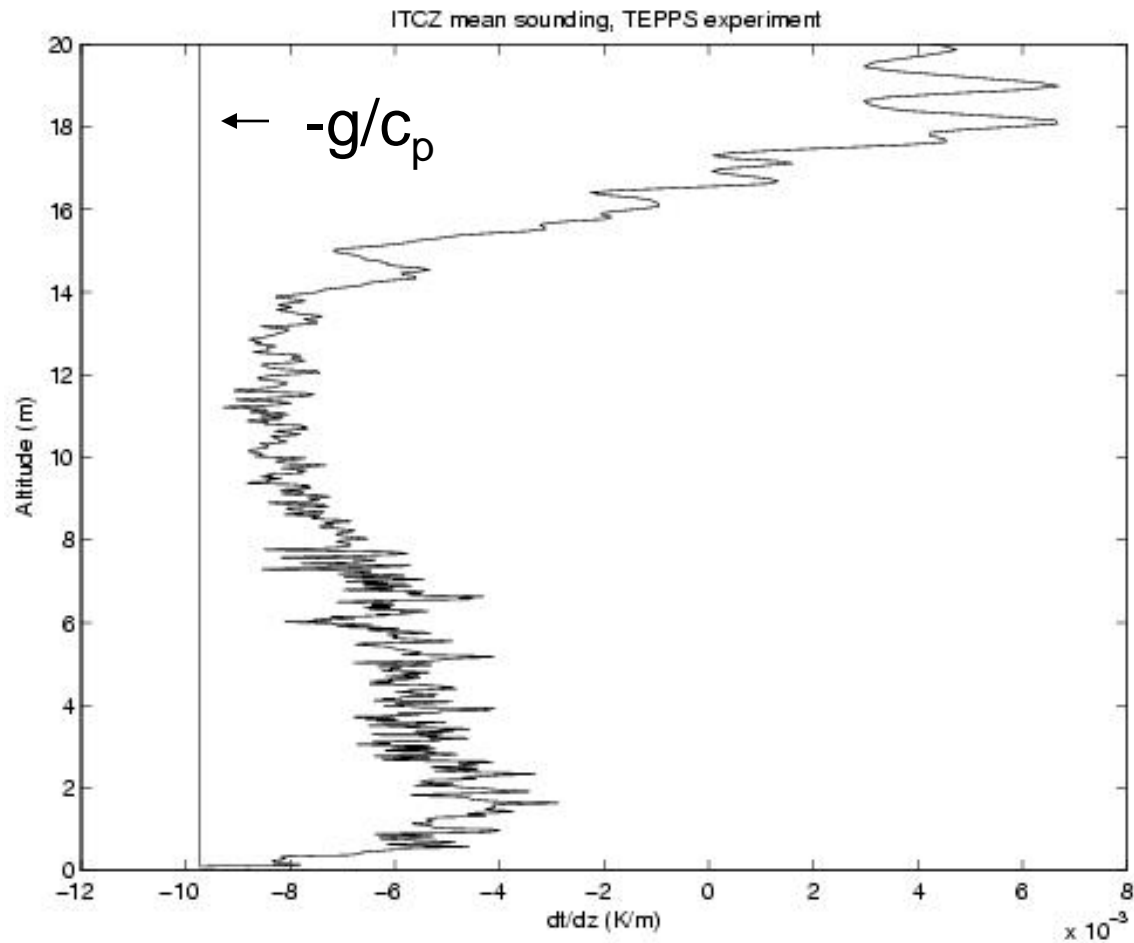

Image from Cifelli et al. 2007, *Mon. Wea. Rev.*,
soundings courtesy Sandra Yuter, NC State

Temperature



Lapse Rate, dT/dz



Potential Temperature

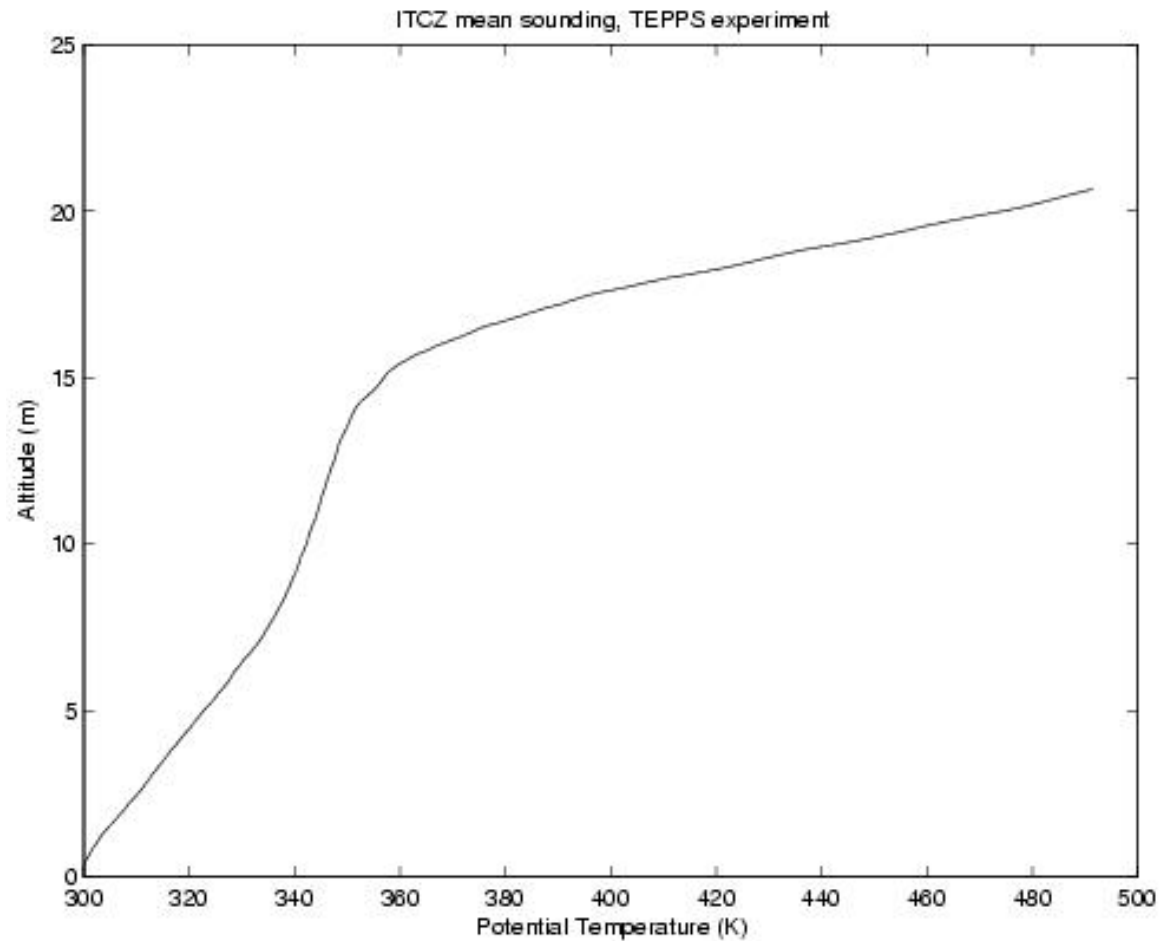

Specific Humidity

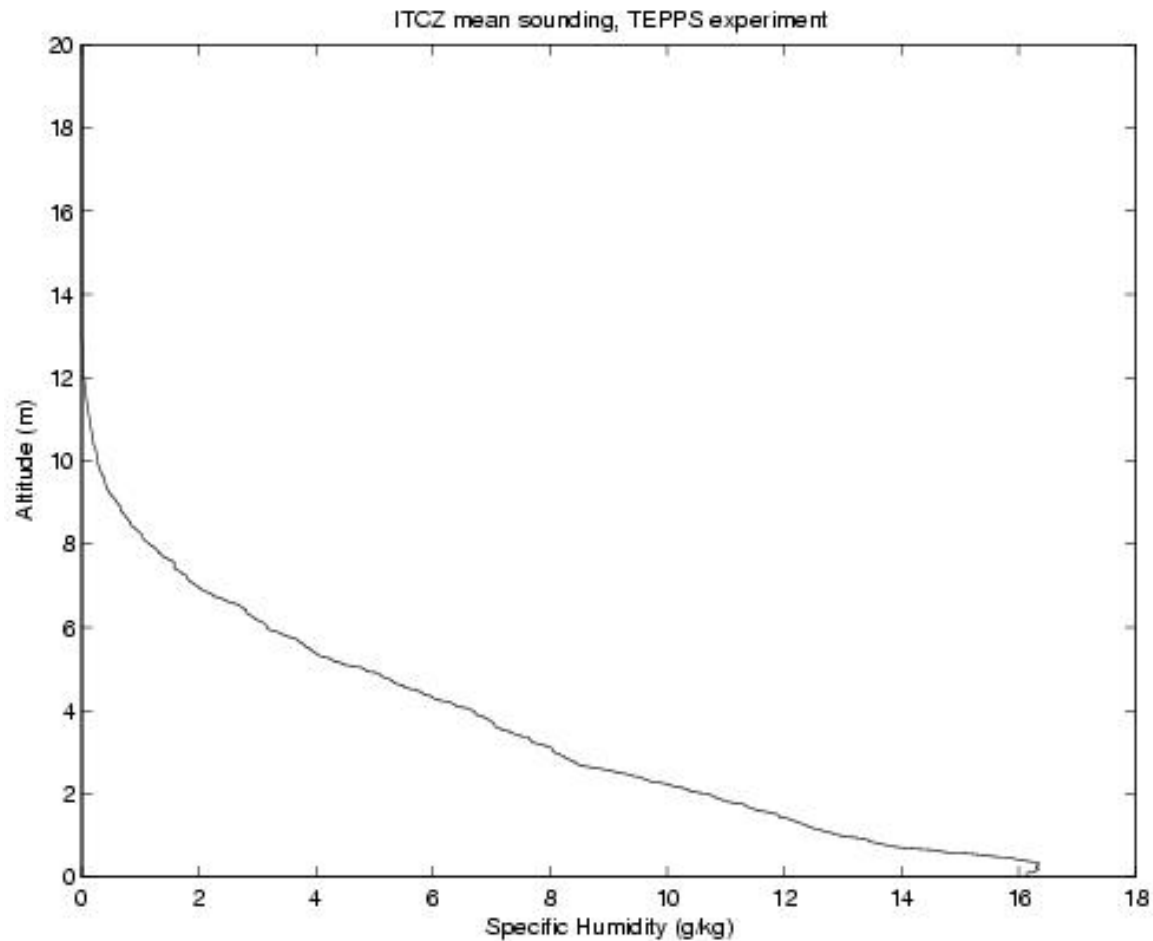

Relative Humidity

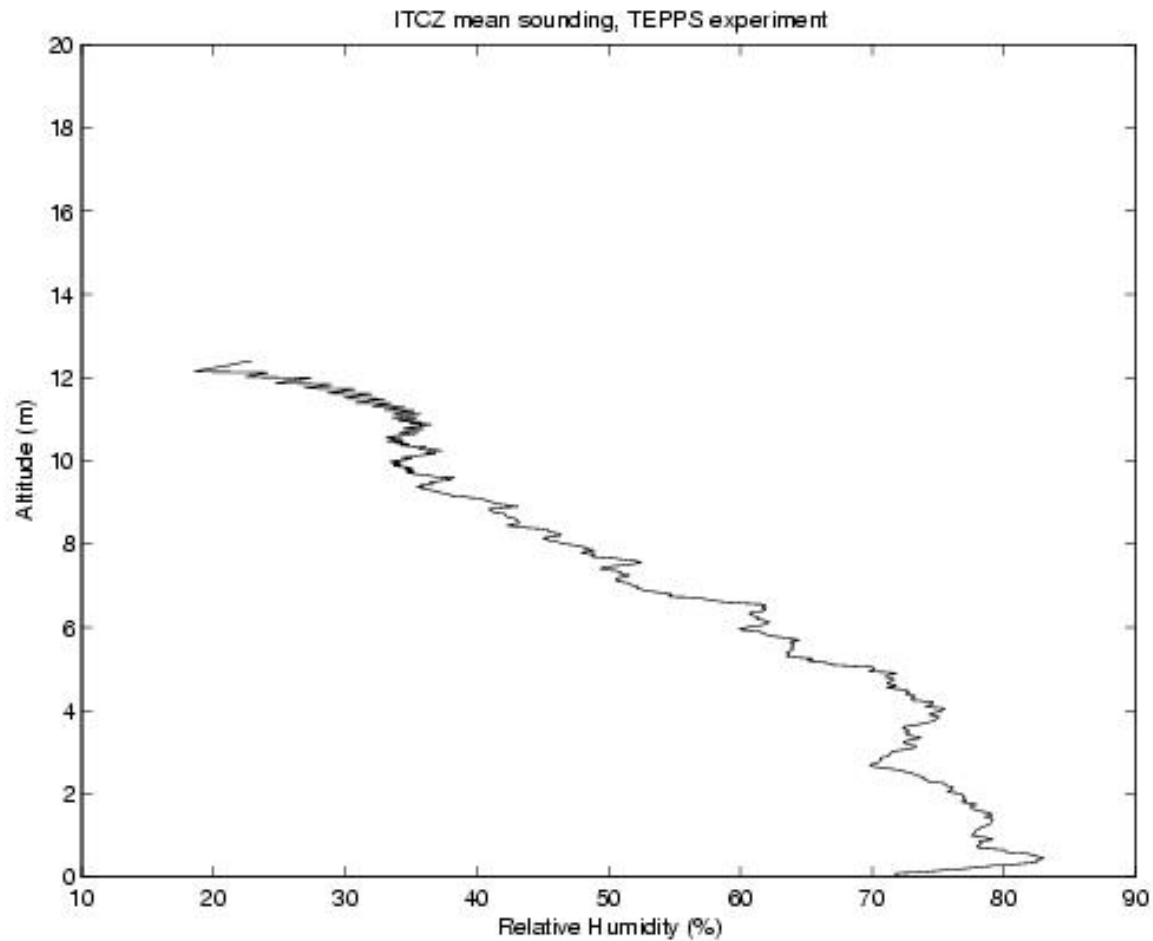

θ_e profiles from Caribbean, and over Amazon

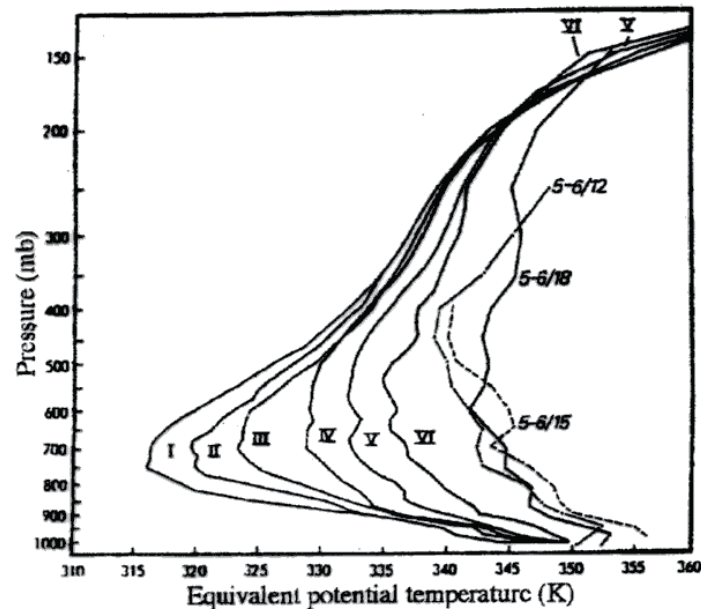

I = suppressed conditions, only shallow cumuli, no rainfall; ...
VI = cumulonimbi, stratus decks, heavy showers. Aspliden 1976,
J. App. Meteor., 15, 692-697.
Scala et al. 1990, JGR 95, 17015-17030

Moist stability, 4 - parcel theory 1

Now we are ready to consider a realistic situation. Imagine we have an unsaturated atmosphere with some profiles $T(z)$, $q(z)$ (or in pressure coordinates $T(p)$, $q(p)$). We want to know whether clouds will form. In general we assume that $N^2 > 0$ (computed from virtual temperature), so the atmosphere is stable to small displacements. But for sufficiently large upward displacements, saturation may occur; then the rules change. This is the notion of **conditional stability**.

We use the *parcel method*. Compute the buoyancy of a hypothetical parcel undergoing some specific finite displacement. We will generally neglect both the virtual temperature effect and the effect of condensate on density. Since we compute only buoyancy, we are also neglecting pressure forces.

Moist stability, 5 - parcel theory 2

Start with an unsaturated parcel which has the properties of the large-scale environment. As it ascends, it will cool adiabatically, conserving θ (or s) as the pressure drops hydrostatically, thus following the dry adiabatic lapse rate. Water vapor mixing ratio r is conserved. At some point, the actual temperature will reach the point at which $r = r^*$, and the parcel will be saturated. This is called the **lifted condensation level** (LCL).

If the sounding is stable to dry displacements ($dT/dz > \Gamma_d$) the parcel will be negatively buoyant at the LCL.

If it continues to rise (forced somehow), it will do so at the moist adiabatic lapse rate. If the sounding lapse rate is steeper (more negative) than moist adiabatic (often the case near the surface), the parcel buoyancy will become less negative with height. The point at which it reaches zero is the **level of free convection** (LFC).

Moist stability, 5 - parcel theory 3

Above the LFC, the parcel is positively buoyant and rises freely. Water continues to condense. (Assume the parcel does not mix with the environment. *This is generally an unrealistic assumption* and we will return to it.)

The parcel's temperature will follow the moist adiabatic lapse rate. At some point (the stratosphere if nowhere else) the parcel will again become cooler than its environment and thus negatively buoyant. This is the **level of neutral buoyancy** (LNB).

We often assume parcel ascent stops at the LNB, although it is reasonable to expect some overshoot, since the parcel will have some momentum when it arrives there.

Moist stability, 6 - CAPE

We define the **convective available potential energy** (CAPE) for a parcel starting at level z_i as the integral of the buoyancy over the entire region where it is positive:

$$CAPE(z_i) = \int_{z=LFC}^{z=LNB} B dz = g \int_{LFC}^{LNB} \frac{\tilde{\rho} - \rho_c}{\tilde{\rho}} dz$$

where ρ_c is the density of the parcel ("c" for cloud) and $\tilde{\rho}$ is the density of the environmental air. In pressure coordinates, using hydrostatic balance for the environment $d\tilde{p}/dz = -\tilde{\rho}g$,

$$CAPE(p_i) = \int_{p_{LNB}}^{p_{LFC}} (\alpha_c - \tilde{\alpha}) dp.$$

Moist stability, 6.5 - CAPE

The CAPE is the total potential energy available to the parcel through buoyant ascent (as its name suggests). If we assume this is all converted to kinetic energy, then it tells us the upward speed of the parcel at the top of its ascent.

$$\frac{1}{2} w_{max}^2 = CAPE,$$

or

$$w_{max} = (2CAPE)^{1/2}.$$

We call this velocity w_{max} because it is not just the maximum value over the entire ascent, but also really an upper bound on that quantity. Pressure forces or mixing of momentum may reduce it, and entrainment of environmental air will in general reduce the buoyancy itself (though sometimes not).

Moist stability, 7 - CIN

We also define the **convective inhibition** (CIN) for a parcel starting at level z_i as the integral of the buoyancy over the entire region where it is negative, from z_i to the LFC:

$$CIN(z_i) = - \int_{z_i}^{z=LFC} B dz = g \int_{z_i}^{z=LFC} \frac{\rho_c - \tilde{\rho}}{\tilde{\rho}} dz$$

or

$$CIN(p_i) = \int_{p_{LFC}}^{p_i} (\tilde{\alpha} - \alpha_c) dp.$$

For both CAPE and CIN, the dependence on z_i (or p_i) is not just a technicality, but strongly influences the value — surface parcels, for example, are often much more buoyant than those just a few hundred meters above the surface. The results will also depend quantitatively on the thermodynamic assumptions (e.g., reversible vs. pseudo-adiabatic). It will also be important to consider *entrainment*.

Moist stability, 8 - skew-T

Numerical computations of CAPE and CIN are useful, but meteorologists also rely heavily on graphical methods for assessing the state of the atmosphere. Two kinds of diagrams we will use are **skew-T log-p** diagrams, and **conserved variable diagrams**.

A skew-T log-p diagram has several non-orthogonal axes. The vertical axis is the logarithm of pressure. The isotherms, or lines of constant temperature, slope from lower left to upper right. Typically the temperature, T , and dew point, T_d are plotted; if $T = T_d$ then the air is saturated. **Dry adiabats** - curves of constant potential temperature, θ , slope from lower right to upper left; **moist adiabats** (usually actually pseudo-adiabatic) are also shown, nearly vertical at bottom and then curving to the left. Lines of constant water vapor mixing ratio are also shown in the lower part of the plot (sloping up to the right, steeper than the isotherms).

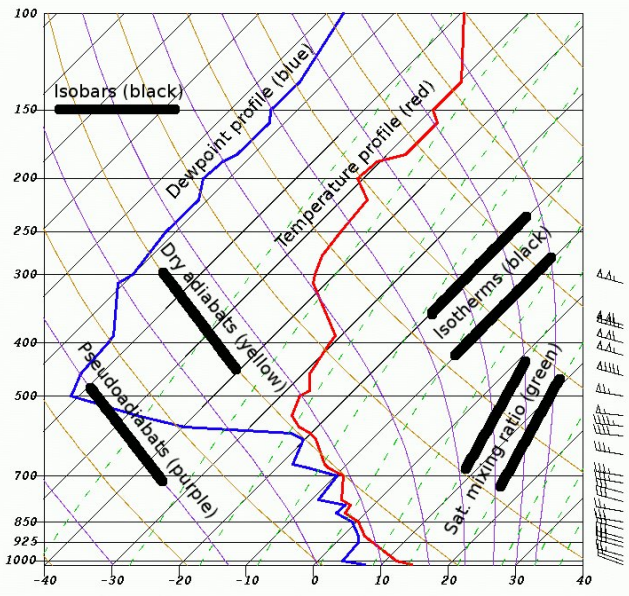

Online skew-T lessons:

Weather Underground skew-T log-p lesson

Millersville University skew-T log-p lesson

UCAR COMET skew-T log-p lesson (requires login)

Schematic skew-T (Bohren and Albrecht)

306 Moist Air and Clouds

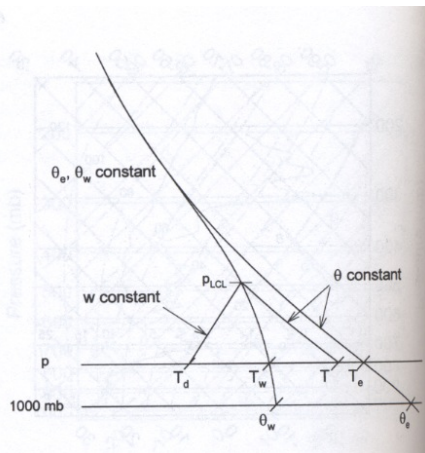
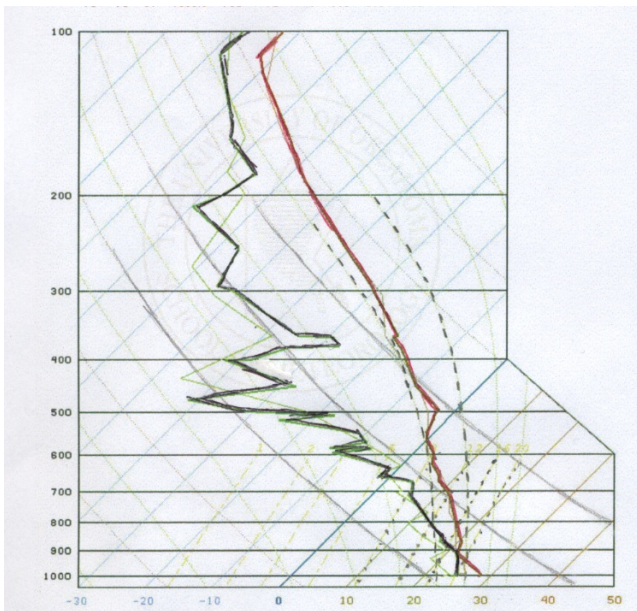

Figure 6.10 Depiction of thermodynamic variations on a skew-T diagram from which all but the essential isopleths are omitted.

Bohren and Albrecht: Atmospheric Thermodynamics, Oxford University Press, New York, pp.306

Exercise: where are the LNB and LFC, for parcels starting at the surface and at 850 hPa?



Answer:

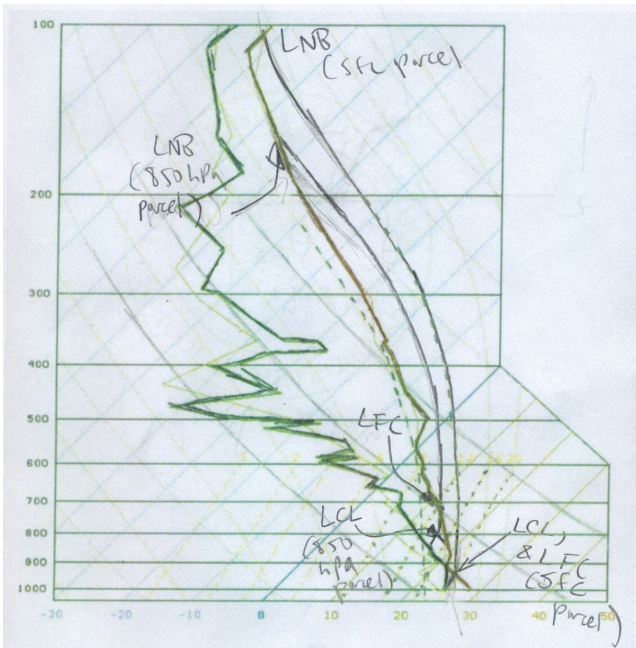

On a skew- T diagram, if there is a region of buoyant ascent — parcel T greater than environmental T — the **CAPE is related to the area between the two curves.**

CIN is related to the "negative area", of the region for which parcel T is less than environmental T .

Moist stability, 9 - conserved variable diagrams

Consider a saturated parcel in an unsaturated environment. Let θ_{ec} be the parcel equivalent potential temperature (reversible) and $\tilde{\theta}_e^*$ be the saturation equivalent potential temperature of the environment. (Note $\tilde{\theta}_e^*$ depends only on T and p). We can show (Bohren and Albrecht p. 297; somewhat different notation) that

$$\theta_c - \tilde{\theta} \approx \frac{\theta_{ec} - \tilde{\theta}_e^*}{1 + \beta}$$

where $\beta = (L_v/c_p)\partial r^*/\partial T$ is of order 1. Thus if we neglect condensate loading and other effects, parcel buoyancy is roughly proportional to the difference between parcel θ_e and environmental θ_e^* . A similar result can be shown for parcel moist static energy h and environmental saturation moist static energy h^* .

This motivates **conserved variable diagrams**, in which we plot θ_e and θ_e^* (or h and h^*) as a function of height.

Exercise: is this sounding conditionally unstable?

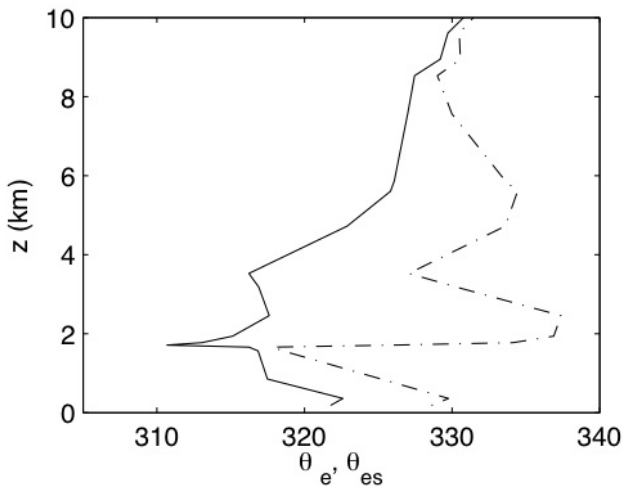

Answer: yes, to shallow convection.

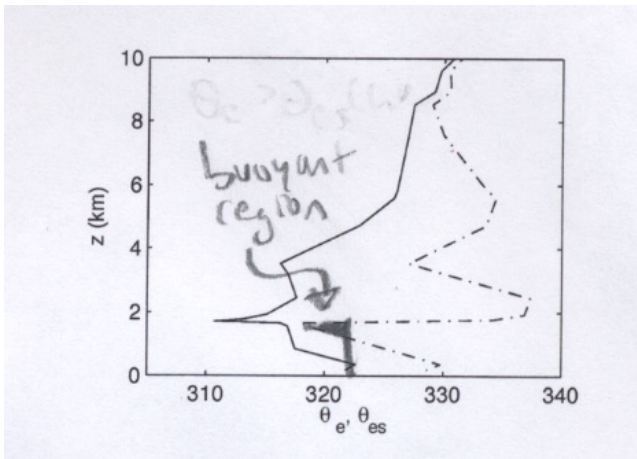

Conserved variables and mixing in clouds, 1

Conserved variables can be helpful when studying details of cloud processes.

Consider a mixture of two parcels, with proportions M and $1 - M$. Let ξ be any linearly mixing conserved quantity, its values in the two parcels are ξ_1, ξ_2 . The mixture has $\xi = M\xi_1 + (1 - M)\xi_2$. If we make a scatter plot of two such conserved variables on which each point is a different fluid sample, they will fall along a line if all are mixtures of the same two end members, just with different values of M .

In non-precipitating cumulus clouds, one can assume that equivalent potential temperature θ_e and total water q_T are conserved.

Conserved variables and mixing in clouds, 2

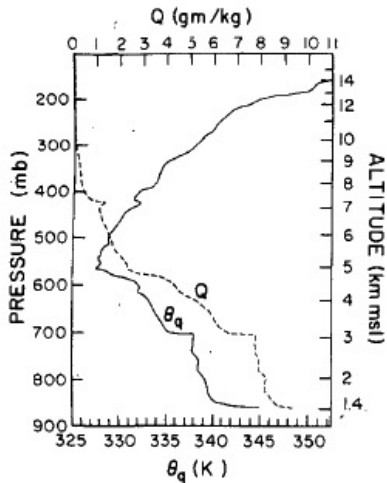

From Paluch (1979, J. Atmos. Sci.)

Conserved variables and mixing in clouds, 3

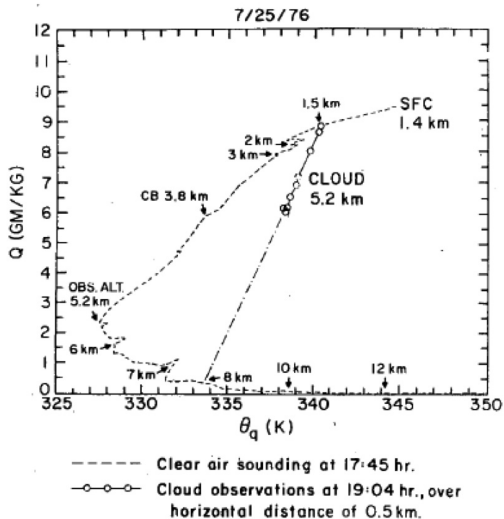

From Paluch (1979, J. Atmos. Sci.)

Conserved variables and mixing in clouds, 4

Now consider a buoyant saturated parcel rising in a cloud updraft through an unsaturated environment.

If the parcel is rising it implies that θ_e of the parcel is greater than θ_e^* of the environment (and thus also greater than θ_e of the environment since $\theta_e \leq \theta_e^*$). **If environmental air is mixed into the parcel, its θ_e will be reduced, as will its buoyancy.**

In tropical clouds over ocean, buoyancy is generally small and the reduction due to mixing is due to the subsaturation, rather than temperature deficit, of the environment. Mixing in of dry air causes condensate to evaporate, cooling the parcel. This effect is stronger, for a given **entrainment rate**, the drier is the environment.

This effect is important in the atmosphere — most convective clouds entrain significantly through the sides (Paluch 1979 notwithstanding).

Non-entraining parcel theory gives only an upper bound on cloud buoyancy.

Arakawa and Schubert (1974) based their convection scheme on a "cloud work function", a CAPE-like quantity that accounts for entrainment.

We now begin to describe more directly the properties of convecting atmospheres. We start with the dry convective boundary layer. Most common over land, this is a layer with turbulence driven by surface heating in which condensation does not occur. It differs from Rayleigh-Benard convection most importantly in that there is no upper boundary, and that the free atmosphere above the convecting layer is stably stratified.

Dry convective boundary layer over land, 1

At night, if the atmosphere is dry, the surface cools faster than the land, by radiation to space. The night-time boundary layer becomes **stable** - $\partial\theta_v/\partial z > 0$.

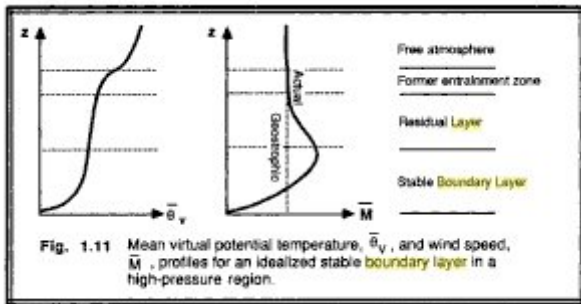

Stull, 1988: An Introduction to Boundary Layer Meteorology, Kluwer Academic Press, pp.16

From Stull, ch. 9 of latest edition of Wallace & Hobbs.

Dry convective boundary layer over land, 2

When the sun comes out the surface heats up, destabilizing a layer just above ground. Convective turbulent mixing homogenizes θ_v over a deeper and deeper layer.

Stull, 1988: An Introduction to Boundary Layer Meteorology, Kluwer Academic Press, pp.17

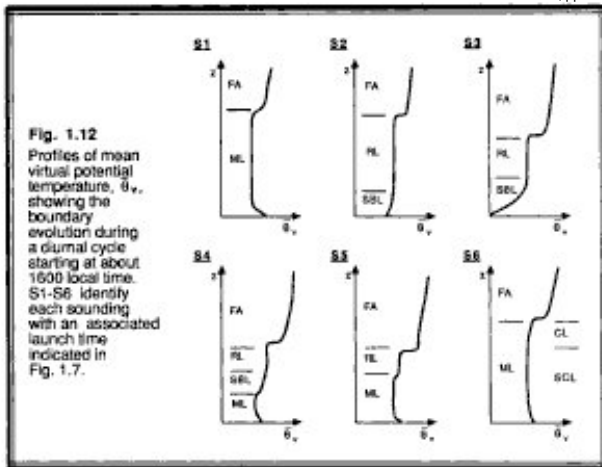
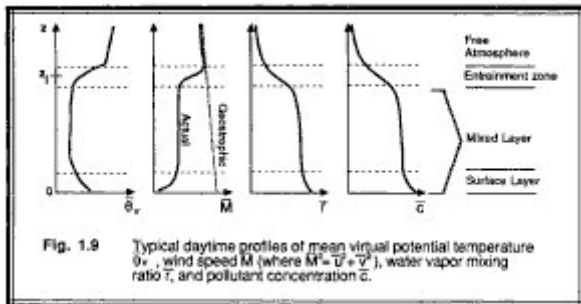

Fig. 1.12
Profiles of mean virtual potential temperature, θ_v , showing the boundary evolution during a diurnal cycle starting at about 1600 local time. S1-S6 identify each sounding with an associated launch time indicated in Fig. 1.7.

Dry convective boundary layer over land, 3

The well-developed daytime boundary layer has uniform θ_v with height, between an unstable surface layer whose depth is controlled by roughness (or over a purely smooth surface, diffusion) and an **inversion** where the mixed layer meets the stable free atmosphere.



Stull, 1988: An Introduction to Boundary Layer Meteorology, Kluwer Academic Press, pp.13

From Stull, ch. 9 of latest edition of Wallace & Hobbs.

Dry convective boundary layer over land, 4

How is this similar to or different from Rayleigh-Benard convection?

- There is a conserved buoyancy variable (here θ_v) whose mean profile becomes uniform with height, apart from thin layers near the boundaries. (**similar**)
- The dominant eddies have horizontal scales comparable to the depth of the layer. (**similar**)
- One key **difference** derives from the inversion at the top. Turbulent eddies mix free-atmospheric air with high θ_v down into the boundary layer - this is **entrainment**. At the inversion, the net heat flux $\overline{\rho w \theta_v}$ is **downwards**; it is roughly proportional to the surface flux of θ_v , proportionality constant ~ 0.2 .
- Humidity also becomes well-mixed. As the PBL deepens, temperature at its top (just below the inversion) becomes lower. Eventually condensation may occur, and clouds form — another **different** phenomenon not found in RBC!

Dry convective boundary layer over land, 5

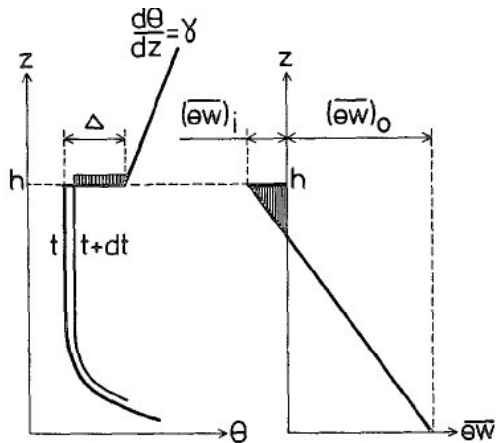

FIG. 1. The vertical distributions of potential temperature and turbulent heat flux in and above a convective boundary layer.

From Tennekes, 1973, *J. Atmos. Sci.*

Moist convective asymmetry and tropical atmospheric structure, 1

We now need to discuss perhaps the most fundamental difference between moist cumulus convection and dry convection. This is the **asymmetry between updrafts and downdrafts**.

In unsaturated conditionally unstable atmospheres, surface- or near-surface parcels which start with the thermodynamic properties of the large-scale environment can undergo free ascent after reaching the LCL.

However, the free troposphere is almost always stably stratified to dry displacements, $\partial\theta_v/\partial z > 0$ — thus **unconditionally stable** to downward displacements of free-tropospheric air.

Moist convective asymmetry and tropical atmospheric structure, 2

Condensate can lead to negatively buoyant downdrafts - by condensate evaporation and direct loading. But an unsaturated parcel will not experience any such effects, so they are limited to the immediate vicinity of updrafts which produce clouds and rain.

So **updrafts from the surface can develop spontaneously** in an unsaturated atmosphere, given a little forcing; **downdrafts from aloft cannot**.

As a consequence, cumulus convection — moist convection driven by free buoyant ascent — occurs via ascent in concentrated regions, while descent is more broadly distributed.

(NB: an exception to this, as we will see is the marine stratocumulus boundary layer, which in some ways is more similar to dry convection.)

Moist convective asymmetry and tropical atmospheric structure, 3

Consider a cumulus cloud as a localized heat source in a dry, stably stratified atmosphere. Consider linear response to instantaneous switch-on (Bretherton and Smolarkiewicz 1989, *J. Atmos. Sci.*)

Remote atmosphere warms by **compensating descent**, communicated outwards by internal gravity wave front.

Moist convective asymmetry and tropical atmospheric structure, 4

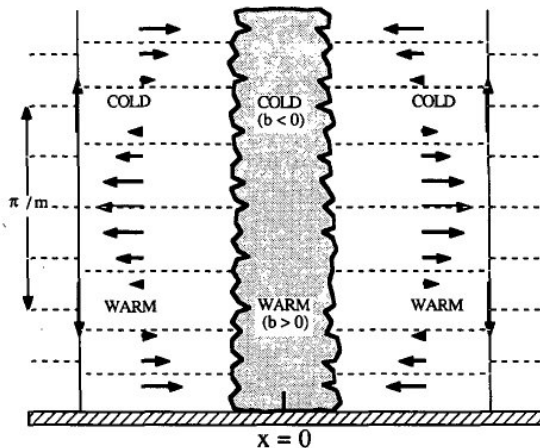

Bretherton and Smolarkiewicz
1989, J. Atmos. Sci.

FIG. 6. The response to an idealized cloud maintaining a sinusoidal buoyancy perturbation in an atmosphere of uniform stratification.

Moist convective asymmetry and tropical atmospheric structure, 5

So heat can be transported over large distances without material transport of fluid over those distances. Moisture, on the other hand, must be materially transported.

So the natural end state of a nonrotating atmosphere with a steady cumulus cloud is a **moist adiabatic** temperature profile (no buoyancy difference from cloud itself) and **unsaturated** moisture profile.

Planetary rotation will limit the scale of this **convective adjustment**, but is weak in the tropics. (Adjustment in a rotating atmosphere to an initial density anomaly is called **geostrophic adjustment**.)

Radiative-convective equilibrium and zero- dimensional climate physics

Adam Sobel

Radiative vs. radiative-convective equilibria (dry and moist)

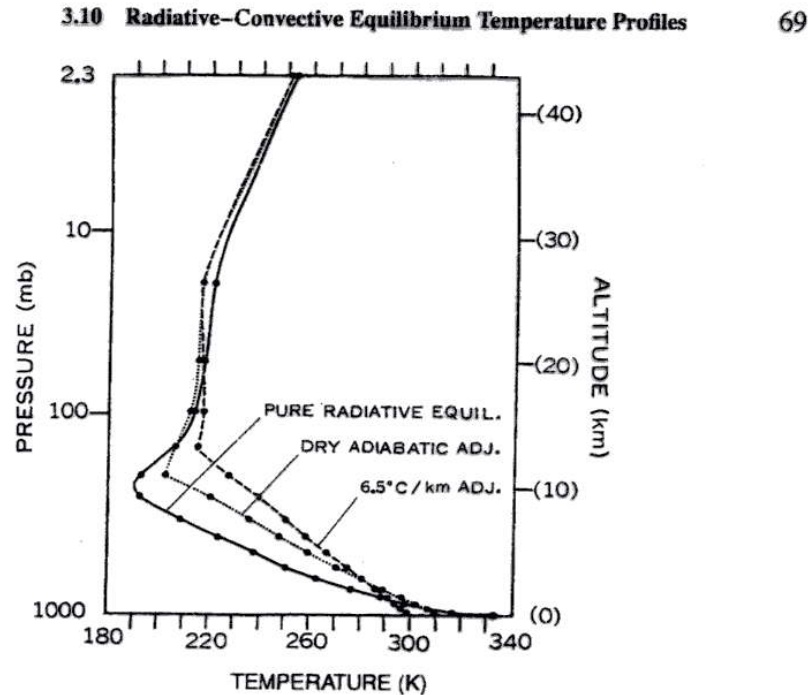

Fig. 3.16 Calculated temperature profiles for radiative equilibrium, and thermal equilibrium with lapse rates of $9.8^{\circ}\text{C km}^{-1}$ and $6.5^{\circ}\text{C km}^{-1}$. [From Manabe and Strickler (1964). Reprinted with permission from the American Meteorological Society.]

Manabe and Strickler 1964, J. Atmos. Sci. 21, 361-385.

- In pure radiative equilibrium, the troposphere is highly unstable to convection (dry or moist)
- Convective adjustment to a specified lapse rate is assumed
- Constant relative humidity
- Specified trace gas concentrations as in earth's atmosphere
- Convection cools the surface; moist cools it more (why?)

3.10 Radiative-Convective Equilibrium Temperature Profiles

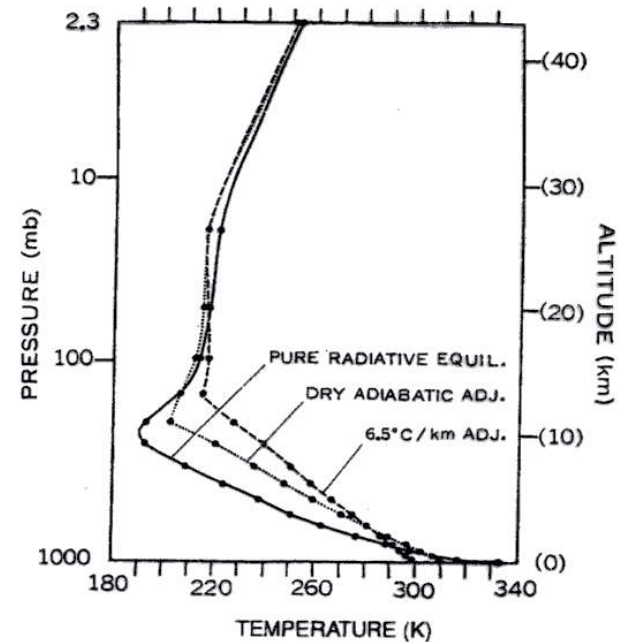
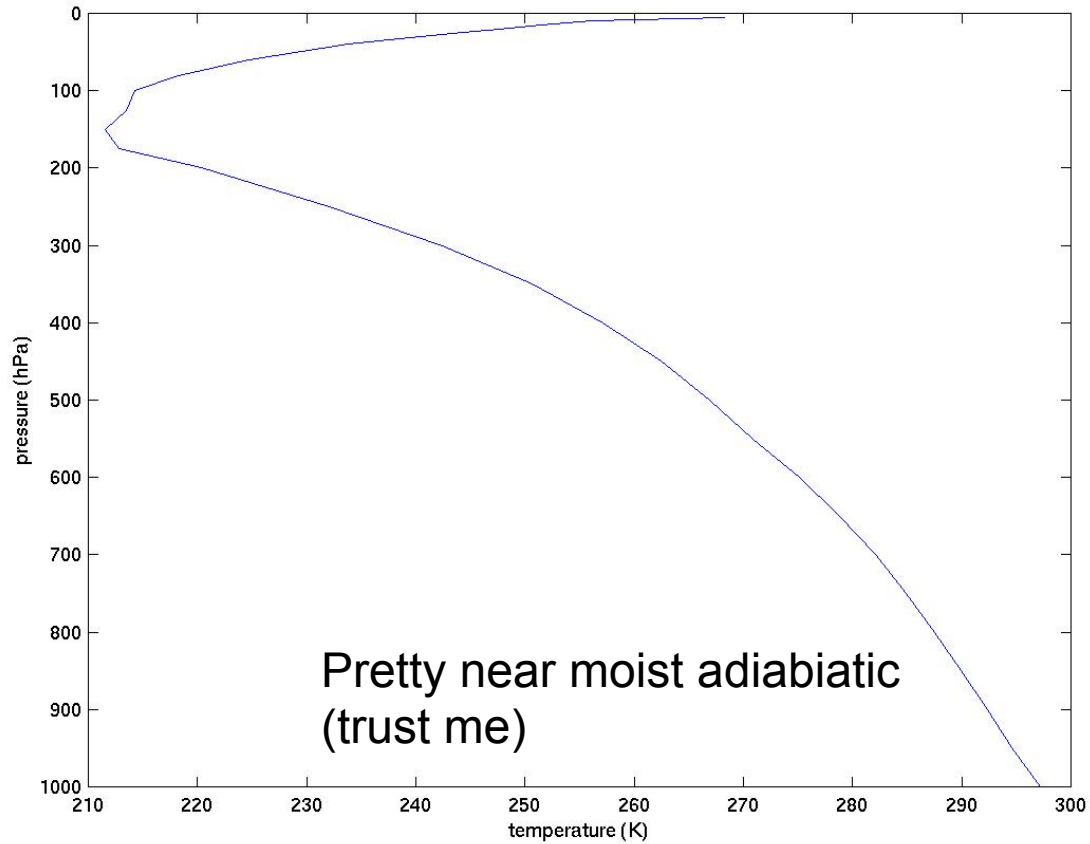

Fig. 3.16 Calculated temperature profiles for radiative equilibrium, and thermal equilibrium with lapse rates of $9.8^{\circ}\text{C km}^{-1}$ and $6.5^{\circ}\text{C km}^{-1}$. [From Manabe and Strickler (1964). Reprinted with permission from the American Meteorological Society.]

Calculations with Kerry Emanuel's single-column model, Renno et al., JGR, 1994

- Convective and (clear-sky) radiation parameterizations
- Slab ocean mixed layer
- Annual average insolation
- CO₂, Ozone at reasonable values
- Surface wind speed=7 m/s
- Surface albedo tuned to give reasonable climate near equator

Temperature



Specific humidity

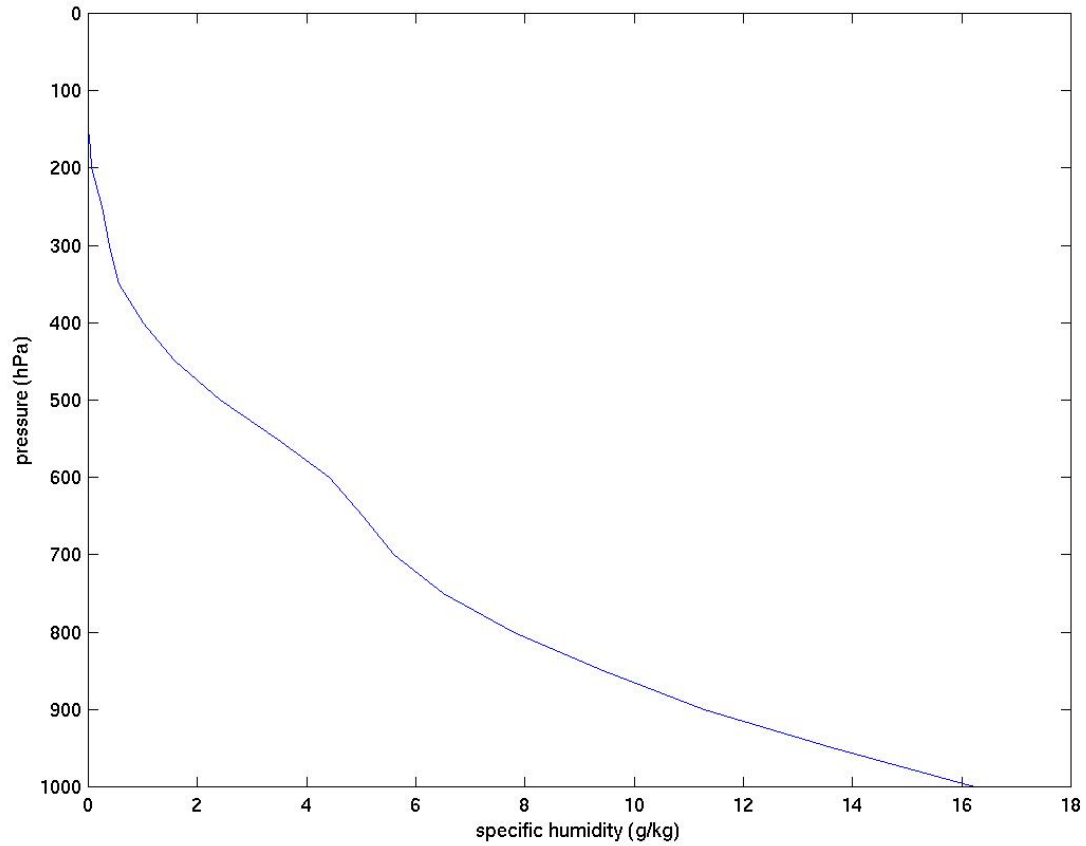

Relative humidity

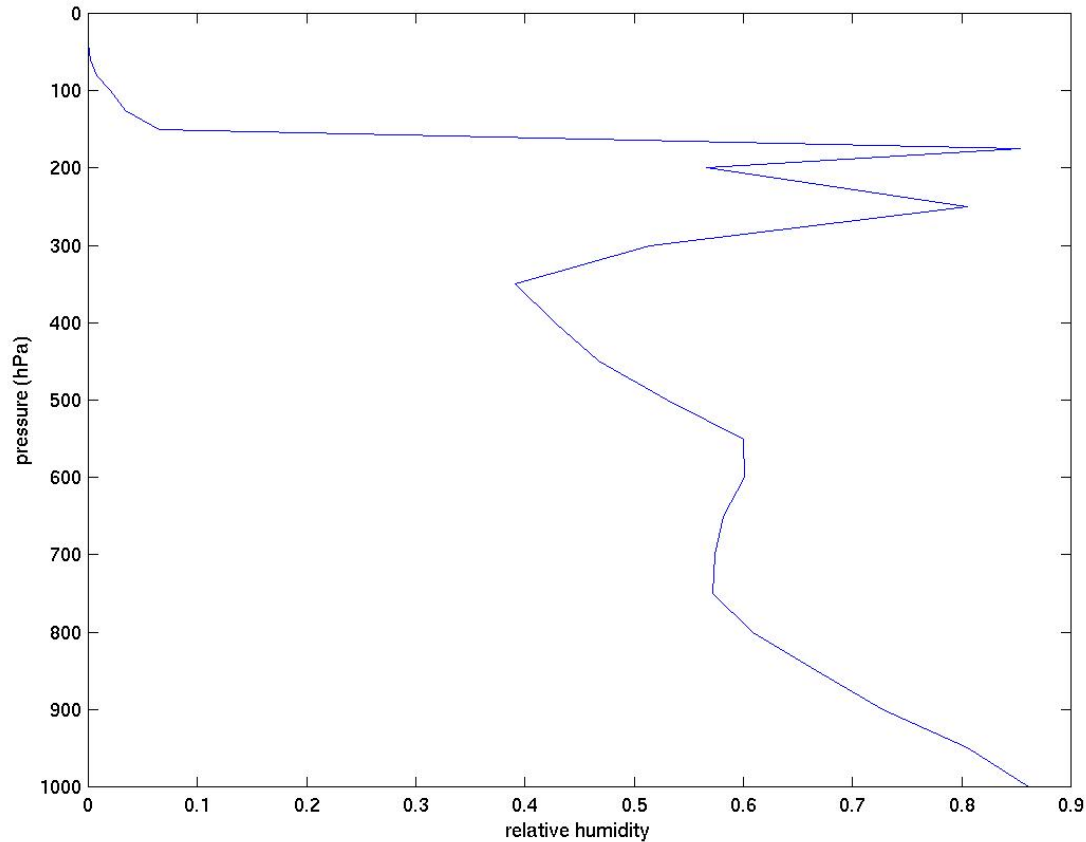

(this result very sensitive to details of convective parameterization)

Moist static energy

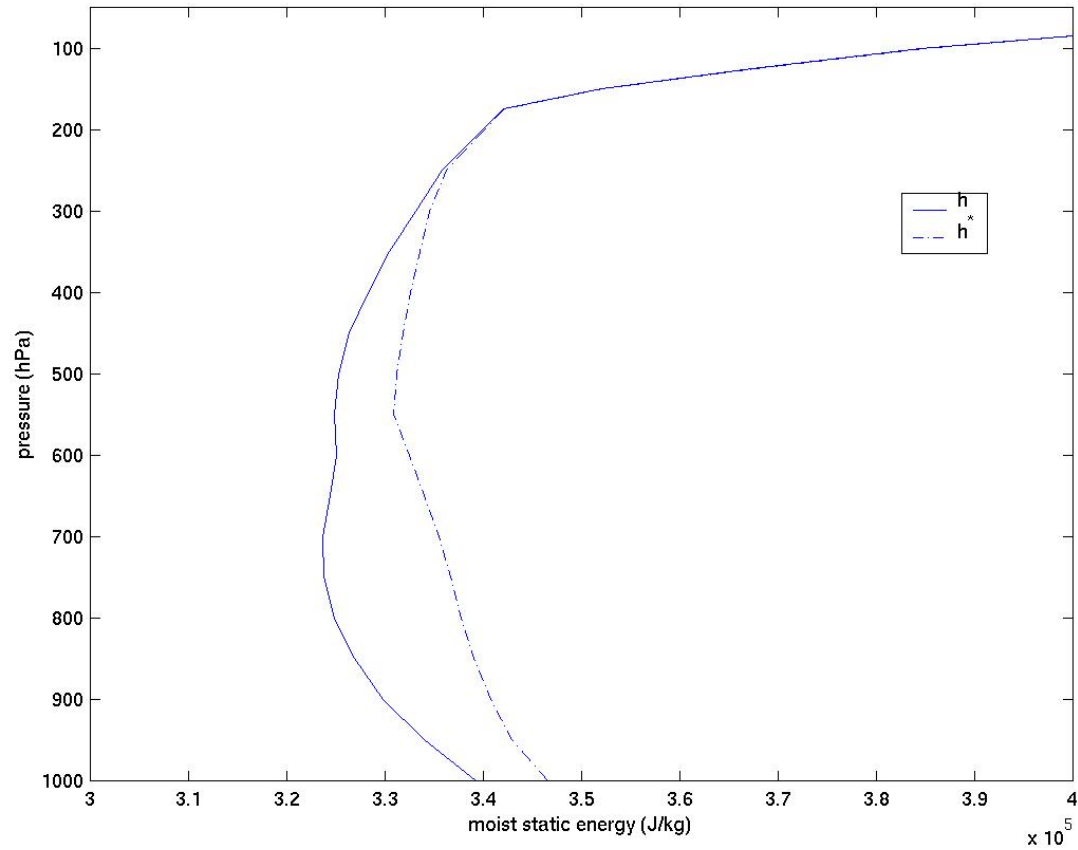

Rad-conv. equilibrium temperature as a function of latitude, annual average radiation

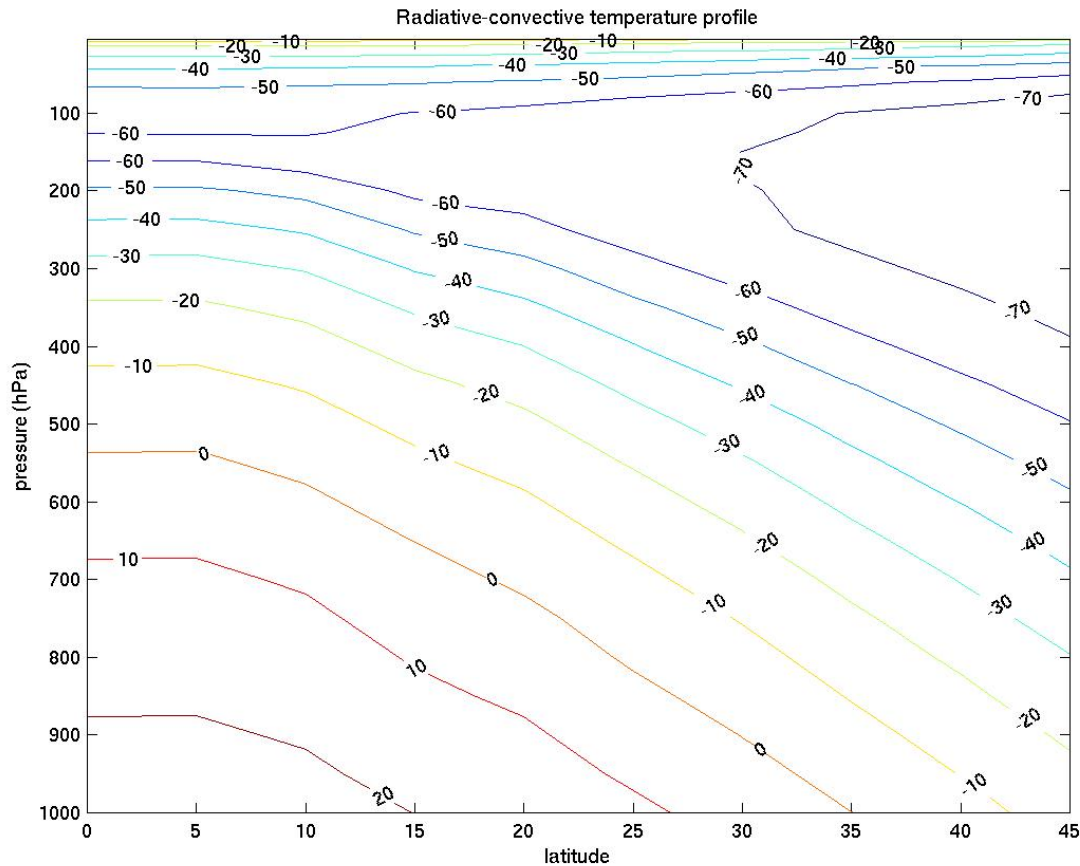

Albedo tuned to give ~realistic sounding at equator. Note x axis only goes to 45 degrees, already well below freezing at surface.

RCE predicts:

- Height of the tropopause
- As climate warms, relative humidity \sim constant; q increases as q^* (Clausius-Clapeyron)
- Precipitation must equal evaporation; Precipitation plus sensible heat flux must equal net radiative cooling
- These latter two allow us to understand some basic aspects of global warming

Climate models predict that water vapor increases as Clausius-Clapeyron ($\sim 7.5\%/K$), but precipitation much more slowly

(a) % column water vapor change

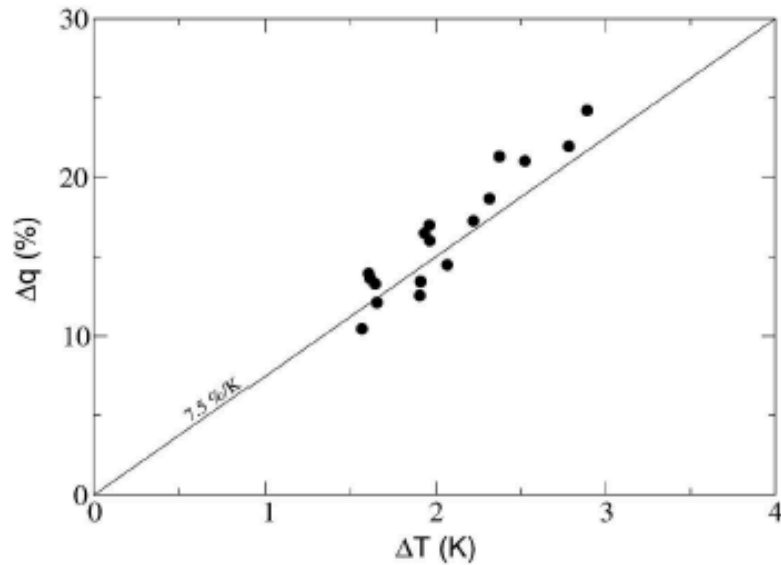

(b) % precipitation change

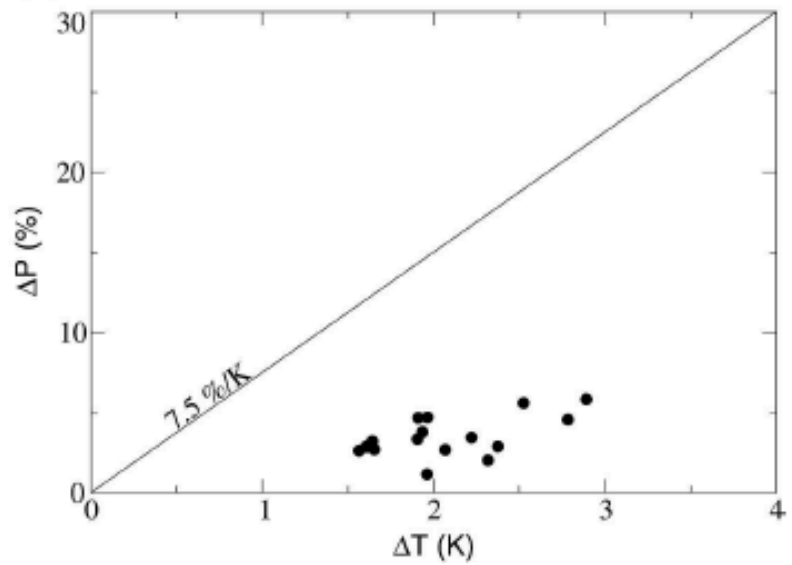

Global mean surface air temperature change

% column water vapor change % precipitation change

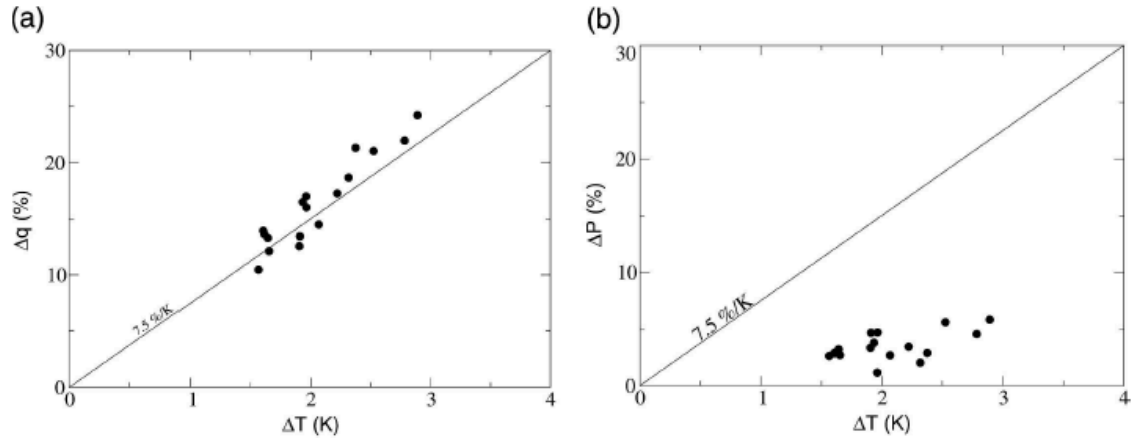

Global mean surface air temperature change

- **Why is this?**

- Relative humidity stays \sim constant; water vapor content is limited by saturation – even where the atmosphere is very subsaturated
- Precipitation cannot increase with water vapor because it is constrained by energetics. It can increase only as fast as atmospheric radiative cooling (and surface evaporation) can.

These statements are only true **globally**. Locally, transports are important and precipitation changes can be much larger.

References 1

- Arakawa, A., Schubert, W. H., 1974: Interaction of a Cumulus Cloud Ensemble with the Large-Scale Environment, Part I. *J. Atmos. Sci.*, 31, 674–701.
- Aspliden, C. I., 1976: A Classification of the Structure of the Tropical Atmosphere and Related Energy Fluxes. *J. Appl. Meteor.*, 15, 692–697.
- Bohren, C. F., Albrecht, B. A.: *Atmospheric Thermodynamics*. Oxford University Press, New York.
- Bretherton, C. S., Smolarkiewicz, P. K., 1989: Gravity Waves, Compensating Subsidence and Detrainment around Cumulus Clouds. *J. Atmos. Sci.*, 46, 740–759.
- Cifelli, R., Nesbitt, S. W., Rutledge, S. A., Petersen, W. A., Yuter, S., 2007: Radar Characteristics of Precipitation Features in the EPIC and TEPPS Regions of the East Pacific. *Mon. Wea. Rev.*, 135, 1576–1595.
- Emanuel, K. A., 1994: *Atmospheric Convection*. Oxford U. P., New York.
- Held, I. M., Soden, B. J., 2006: Robust Responses of the Hydrological Cycle to Global Warming. *J. Climate*, 19, 5686–5699.

References 2

- Manabe, S., Strickler, R. F., 1964: Thermal Equilibrium of the Atmosphere with a Convective Adjustment. *J. Atmos. Sci.*, 21, 361–385.
- Paluch, I. R., 1979: The Entrainment Mechanism in Colorado Cumuli. *J. Atmos. Sci.*, 36, 2467–2478.
- Rennó, N. O., Emanuel, K. A., Stone, P. H.: Radiative-convective model with an explicit hydrologic cycle: 1. Formulation and sensitivity to model parameters. *J. Geophys. Res.*, 99, 14429-14441.
- Scala, J. R., Garstang, M., Tao, W-k, Pickering, K. E., Thompson, A. M., Simpson, J., Kirchhoff, V. W. J. H., Browell, E. V., Sachse, G. W., Torres, A. L., Gregory, G. L., Rasmussen, R. A., Khalil, M. A. K., 1990: Cloud draft structure and trace gas transport. *J. Geophys. Res.*, 95, 17015–17030.
- Stevens, B., 2006: Bulk boundary-layer concepts for simplified models of tropical dynamics. *Theor. Comp. Fluid Dyn.* 20:5-6, 279-304.
- Stull, R. B., 1988: *An Introduction to Boundary Layer Meteorology*. Kluwer Academic Publishers.

References 3

- Tennekes, H., 1973: A Model for the Dynamics of the Inversion Above a Convective Boundary Layer. *J. Atmos. Sci.*, 30, 558–567.
- Wallace, J. M., Hobbs, P. V.: *Atmospheric science - an introductory survey*. New York, NY (USA): Academic Press, 467 p.